

12-3 Surface Areas of Pyramids and Cones

Find the lateral area and surface area of each regular pyramid. Round to the nearest tenth if necessary.

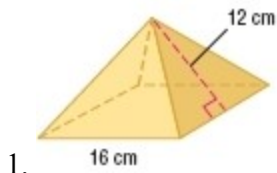

SOLUTION:

The lateral area L of a regular pyramid is $L = \frac{1}{2}P\ell$, where ℓ is the slant height and P is the perimeter of the base. Here, the base is a square of side 16 cm and the slant height is 12 cm.

$$\begin{aligned}L &= \frac{1}{2}P\ell \\ &= \frac{1}{2}(4 \times 16)(12) \\ &= 384\end{aligned}$$

So, the lateral area of the pyramid is 384 cm^2 .

The surface area S of a regular pyramid is $S = L + B$, where L is the lateral area and B is the area of the base.

$$\begin{aligned}S &= \frac{1}{2}P\ell + s^2 \\ &= \frac{1}{2}(4 \times 16)(12) + (16)^2 \\ &= 384 + 256 \\ &= 640\end{aligned}$$

Therefore, the surface area of the pyramid is 640 cm^2 .

ANSWER:

$$L = 384 \text{ cm}^2 ; S = 640 \text{ cm}^2$$

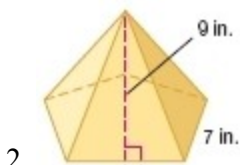

SOLUTION:

First, find the lateral area.

The lateral area L of a regular pyramid is $L = \frac{1}{2}P\ell$, where ℓ is the slant height and P is the perimeter of the base.

The base is a regular pentagon of side 7 in. and the slant height is 9 in.

12-3 Surface Areas of Pyramids and Cones

$$L = \frac{1}{2}(5 \times 7)(9) \text{ or } 157.5 \text{ in}^2$$

The surface area S of a regular pyramid is $S = L + B$, where L is the lateral area and B is the area of the base.

The area of a regular polygon is half the product of the length of the apothem and the perimeter.

$$B = \frac{1}{2}Pa$$

Find the length of the apothem and the area of the base.

A central angle of the pentagon is $\frac{360}{5}$ or 72 , so the angle formed in the triangle below is 36° . Use a trigonometric ratio to find the apothem a .

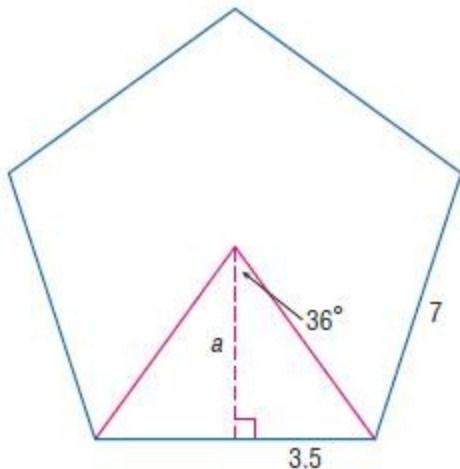

$$\begin{aligned}\tan 36 &= \frac{3.5}{a} \\ a &= \frac{3.5}{\tan 36}\end{aligned}$$

$$\begin{aligned}A &= \frac{1}{2}aP \\ &= \frac{1}{2}\left(\frac{3.5}{\tan 36}\right)(7 \times 5) \\ &\approx 84.3\end{aligned}$$

So, the area of the base B is about 84.3 square inches.

Find the surface area of the pyramid.

$$\begin{aligned}S &= L + B \\ &= 157.5 + 84.3 \\ &= 241.8\end{aligned}$$

Therefore, the surface area of the pyramid is about 241.8 in^2 .

12-3 Surface Areas of Pyramids and Cones

ANSWER:

$$L = 157.5 \text{ in}^2 ; S \approx 241.8 \text{ in}^2$$

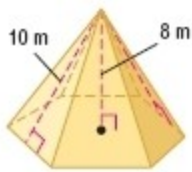

3.

SOLUTION:

The segment joining the points where the slant height and height intersect the base is the apothem.

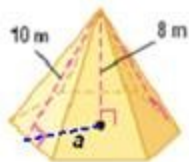

Use the Pythagorean Theorem to find the length the apothem of the base.

$$a^2 + b^2 = c^2$$

$$a = \sqrt{10^2 - 8^2}$$

$$a = \sqrt{36} \text{ or } 6$$

A central angle of the regular hexagon is $\frac{360}{6}$ or 60 , so the angle formed in the triangle below is 30 .

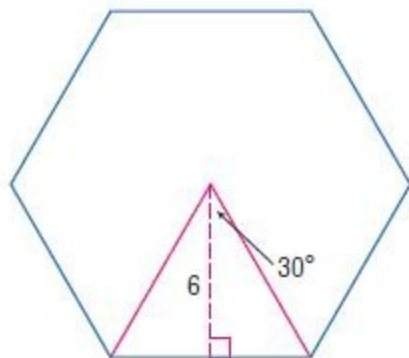

Use a trigonometric ratio to find the length of a side of the hexagon s .

$$\tan 30 = \frac{\frac{s}{2}}{6}$$

$$6 \tan 30 = \frac{s}{2}$$

$$s \approx 12 \tan 30$$

Find the lateral area of the pyramid.

12-3 Surface Areas of Pyramids and Cones

$$\begin{aligned}L &= \frac{1}{2}P\ell \\ &= \frac{1}{2}(6 \times 12 \tan 30)(10) \\ &\approx 207.8\end{aligned}$$

So, the lateral area of the pyramid is about 207.8 m^2 .

Find the surface area of the pyramid.

$$\begin{aligned}S &= \frac{1}{2}P\ell + \frac{1}{2}aP \\ &= \frac{1}{2}(6 \times 12 \tan 30)(10) + \frac{1}{2}(6)(6 \times 12 \tan 30) \\ &\approx 207.846 + 124.708 \\ &\approx 332.6\end{aligned}$$

Therefore, the surface area of the pyramid is about 332.6 m^2 .

ANSWER:

$$L \approx 207.8 \text{ m}^2 ; S \approx 332.6 \text{ m}^2$$

4. **TENTS** A conical tent is shown at the right. Round answers to the nearest tenth.

- Find the lateral area of the tent and describe what it represents.
- Find the surface area of the tent and describe what it represents.



SOLUTION:

- The tent is in the shape of a right circular cone. The radius r is $\frac{13}{2}$ or 6.5 ft and the height is 8 feet. Use the Pythagorean Theorem to find the slant height ℓ .

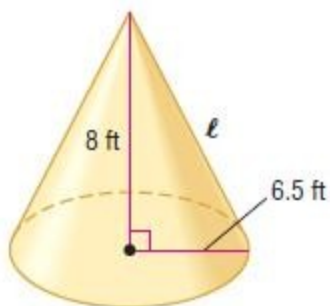

12-3 Surface Areas of Pyramids and Cones

$$\ell^2 = 6.5^2 + 8^2$$

$$\ell = \sqrt{42.25 + 64}$$

$$\ell = \sqrt{106.25}$$

$$\ell \approx 10.3$$

So, the slant height is about 10.3 feet.

Find the lateral area of the cone.

$$\begin{aligned} L &= \pi r \ell \\ &= \pi(6.5)(\sqrt{106.25}) \\ &\approx 210.5 \end{aligned}$$

Therefore, the lateral area is about 210.5 ft^2 . The lateral area would represent the area of the curved surface of the tent or the amount of fabric required for the side of the tent.

b. Find the surface area of the cone.

$$\begin{aligned} S &= \pi r \ell + \pi r^2 \\ &= \pi(6.5)(\sqrt{106.25}) + \pi(6.5)^2 \\ &\approx 210.488 + 132.732 \\ &\approx 343.2 \end{aligned}$$

Therefore, the surface area of the tent is about 343.2 ft^2 . The surface area represents the area of the curved surface plus the area of the tent floor.

ANSWER:

a. 210.5 ft^2 ; the area of the curved surface

b. 343.2 ft^2 ; the area of the curved surface plus the area of the tent floor

12-3 Surface Areas of Pyramids and Cones

CCSS SENSE-MAKING Find the lateral area and surface area of each cone. Round to the nearest tenth.

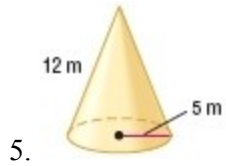

SOLUTION:

The radius is 5 m and the slant height is 12 m.

$$\begin{aligned}L &= \pi r l \\ &= \pi \cdot 5 \cdot 12 \\ &\approx 188.5\end{aligned}$$

$$\begin{aligned}S &= \pi r l + \pi r^2 \\ &= \pi \cdot 5 \cdot 12 + \pi(5)^2 \\ &\approx 188.5 + 25\pi \\ &\approx 267.0\end{aligned}$$

ANSWER:

$$L \approx 188.5 \text{ m}^2 ; S \approx 267.0 \text{ m}^2$$

12-3 Surface Areas of Pyramids and Cones

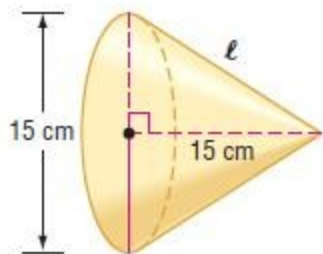

6.

SOLUTION:

The radius is 7.5 cm and the height is 15 cm.

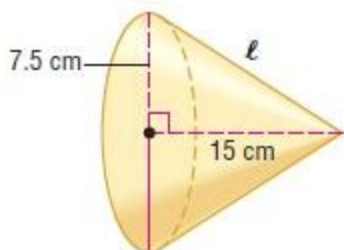

Use the Pythagorean Theorem to find the slant height.

$$a^2 + b^2 = l^2$$

$$15^2 + 7.5^2 = l^2$$

$$281.25 = l^2$$

$$16.8 \approx l$$

Find the lateral and surface area.

$$L = \pi r l$$

$$= \pi \cdot 7.5 \cdot 16.8$$

$$\approx 395.1$$

$$S = \pi r l + \pi r^2$$

$$= \pi \cdot 7.5 \cdot 16.8 + \pi(7.5)^2$$

$$\approx 395.1 + 56.25\pi$$

$$\approx 571.9$$

ANSWER:

$$L \approx 395.1 \text{ cm}^2 ; S \approx 571.9 \text{ cm}^2$$

12-3 Surface Areas of Pyramids and Cones

Find the lateral area and surface area of each regular pyramid. Round to the nearest tenth if necessary.

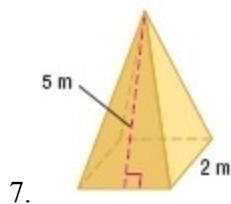

SOLUTION:

The lateral area L of a regular pyramid is $L = \frac{1}{2}P\ell$, where ℓ is the slant height and P is the perimeter of the base. Here, the base is a square of side 2 m and the slant height is 5 m.

$$\begin{aligned} L &= \frac{1}{2}P\ell \\ &= \frac{1}{2}(4 \times 2)(5) \\ &= 20 \end{aligned}$$

So, the lateral area of the pyramid is 20 m^2 .

The surface area S of a regular pyramid is $S = L + B$, where L is the lateral area and B is the area of the base.

$$\begin{aligned} S &= \frac{1}{2}P\ell + s^2 \\ &= \frac{1}{2}(4 \times 2)(5) + (2)^2 \\ &= 20 + 4 \\ &= 24 \end{aligned}$$

Therefore, the surface area of the pyramid is 24 m^2 .

ANSWER:

$$L = 20 \text{ m}^2 ; S = 24 \text{ m}^2$$

12-3 Surface Areas of Pyramids and Cones

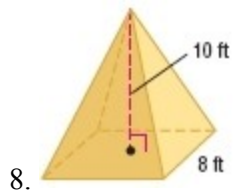

SOLUTION:

The base of the pyramid is a square with side length of 8 feet and the height is 10 feet. Use the Pythagorean Theorem to find the slant height of the pyramid.

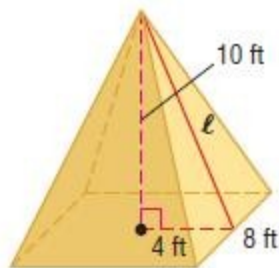

$$l^2 = 4^2 + 10^2$$

$$l^2 = 16 + 100$$

$$l = \sqrt{116}$$

Find the lateral area and surface area of the pyramid.

$$\begin{aligned} L &= \frac{1}{2}P\ell \\ &= \frac{1}{2}(4 \times 8)(\sqrt{116}) \\ &\approx 172.3 \end{aligned}$$

So, the lateral area of the pyramid is about 172.3 ft^2 .

$$\begin{aligned} S &= \frac{1}{2}P\ell + B \\ &= \frac{1}{2}(4 \times 8)(\sqrt{116}) + (8)^2 \\ &\approx 236.3 \end{aligned}$$

Therefore, the surface area of the pyramid is about 236.3 ft^2 .

ANSWER:

$$L \approx 172.3 \text{ ft}^2; S \approx 236.3 \text{ ft}^2$$

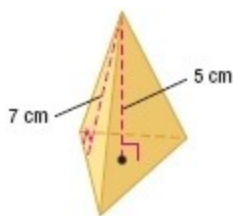

12-3 Surface Areas of Pyramids and Cones

SOLUTION:

Use the right triangle formed by the slant height of 7, the height of 5, and the apothem and the Pythagorean Theorem to find the length of the apothem of the base.

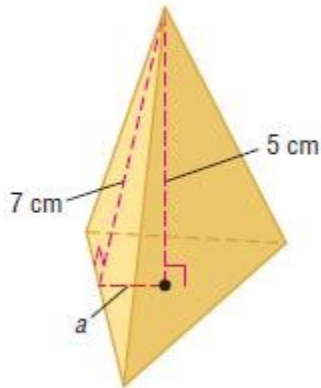

$$a^2 + 5^2 = 7^2$$

$$a^2 = 49 - 25$$

$$a = \sqrt{24} \text{ or } 2\sqrt{6}$$

The base of the pyramid is an equilateral triangle. The measure of each central angle is $\frac{360}{3}$ or 120 , so the angle formed in the triangle below is 60° .

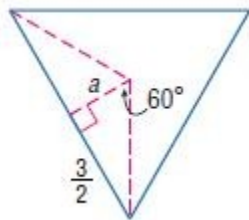

Use a trigonometric ratio to find the length s of each side of the triangle.

$$\tan 60 = \frac{\frac{s}{2}}{a}$$

$$\tan 60 = \frac{\frac{s}{2}}{2\sqrt{6}}$$

$$2\sqrt{6} \tan 60 = \frac{s}{2}$$

$$4\sqrt{6} \tan 60 = s$$

Use the formulas for regular polygons to find the perimeter and area of the base.

$$P = 3 \times 4\sqrt{6} \tan 60 \text{ or } 12\sqrt{6} \tan 60$$

12-3 Surface Areas of Pyramids and Cones

$$\begin{aligned}A &= \frac{1}{2}aP \\ &= \frac{1}{2}(2\sqrt{6})(12\sqrt{6}\tan 60) \\ &\approx 124.7\end{aligned}$$

Find the lateral area and surface area of the pyramid.

$$\begin{aligned}L &= \frac{1}{2}P\ell \\ &= \frac{1}{2}(4 \times 8)(\sqrt{116}) \\ &\approx 178.2\end{aligned}$$

So, the lateral area of the pyramid is about 178.2 cm^2 .

$$\begin{aligned}S &= \frac{1}{2}P\ell + B \\ &\approx 178.2 + 124.7 \\ &\approx 302.9\end{aligned}$$

Therefore, the surface area of the pyramid is about 302.9 cm^2 .

ANSWER:

$$L \approx 178.2 \text{ cm}^2 ; S \approx 302.9 \text{ cm}^2$$

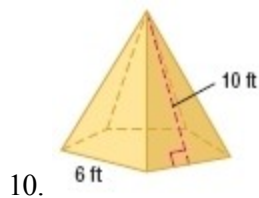

SOLUTION:

First, find the lateral area.

The lateral area L of a regular pyramid is $L = \frac{1}{2}P\ell$, where ℓ is the slant height and P is the perimeter of the base.

$$L = \frac{1}{2}(5 \times 6)(10) \text{ or } 150 \text{ ft}^2.$$

So, the lateral area of the pyramid is 150 ft^2 .

Next, find the length of the apothem and the area of the base.

A central angle of the regular pentagon is $\frac{360}{5}$ or 72° , so the angle formed in the triangle below is 36° . Use a trigonometric ratio to find the apothem a .

12-3 Surface Areas of Pyramids and Cones

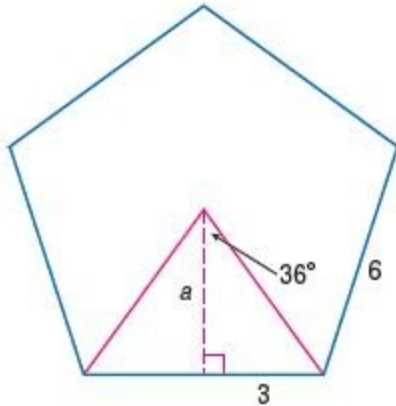

$$\tan 36 = \frac{3}{a}$$

$$a = \frac{3}{\tan 36}$$

$$A = \frac{1}{2}aP$$

$$= \frac{1}{2} \left(\frac{3}{\tan 36} \right) (5 \times 6)$$

$$\approx 61.9$$

So, the area of the base B is about 61.9 square feet.

Find the surface area of the pyramid.

$$S = L + B$$

$$\approx 150 + 61.9$$

$$\approx 211.9$$

Therefore, the surface area of the pyramid is about 211.9 ft^2 .

ANSWER:

$$L = 150 \text{ ft}^2; S \approx 211.9 \text{ ft}^2$$

11. square pyramid with an altitude of 12 inches and a slant height of 18 inches

SOLUTION:

The base of the pyramid is square. Use the Pythagorean Theorem to find the length the apothem of the base.

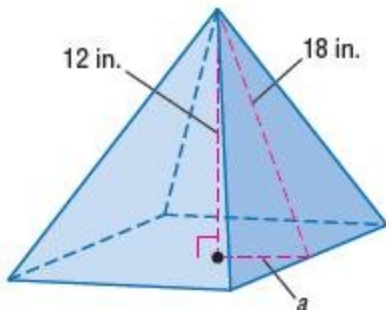

12-3 Surface Areas of Pyramids and Cones

$$a^2 + 12^2 = 18^2$$

$$a^2 = 324 - 144$$

$$a = \sqrt{180} \text{ or } 6\sqrt{5}$$

A central angle of the square is $\frac{360}{4}$ or 90° , so the angle formed in the triangle below is 45° .

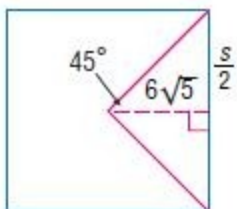

Use a trigonometric ratio to find the length of each side of the square.

$$\tan 45 = \frac{\frac{s}{2}}{6\sqrt{5}}$$

$$6\sqrt{5}\tan 45 = \frac{s}{2}$$

$$12\sqrt{5}\tan 45 = s$$

Find the perimeter and area of the base.

$$P = 4 \times 12\sqrt{5}\tan 45 \text{ or } 48\sqrt{5}\tan 45$$

$$A = (12\sqrt{5}\tan 45)^2$$

Find the lateral area and surface area of the pyramid.

$$\begin{aligned} L &= \frac{1}{2}P\ell \\ &= \frac{1}{2}(48\sqrt{5}\tan 45)(18) \\ &\approx 966.0 \end{aligned}$$

So, the lateral area of the pyramid is about 966 in^2 .

$$\begin{aligned} S &= \frac{1}{2}P\ell + B \\ &\approx \frac{1}{2}(48\sqrt{5}\tan 45)(18) + (12\sqrt{5}\tan 45)^2 \\ &\approx 966.0 + 720.0 \\ &\approx 1686.0 \end{aligned}$$

Therefore, the surface area of the pyramid is about 1686.0 in^2 .

12-3 Surface Areas of Pyramids and Cones

ANSWER:

$$L \approx 966.0 \text{ in}^2 ; S \approx 1686.0 \text{ in}^2$$

12. hexagonal pyramid with a base edge of 6 millimeters and a slant height of 9 millimeters

SOLUTION:

The base of the pyramid is a regular hexagon. The perimeter of the hexagon is $P = 6 \times 6$ or 36 mm.

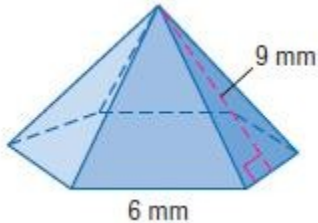

Find the lateral area L of a regular pyramid.

$$\begin{aligned} L &= \frac{1}{2} P \ell \\ &= \frac{1}{2} (36)(9) \\ &= 162 \end{aligned}$$

So, the lateral area of the pyramid is 162 mm^2 .

A central angle of the hexagon is $\frac{360}{6}$ or 60° , so the angle formed in the triangle below is 30° .

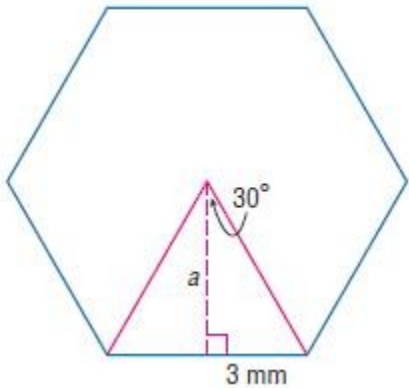

Use a trigonometric ratio to find the apothem a and then find the area of the base.

$$\begin{aligned} \tan 30 &= \frac{3}{a} \\ a &= \frac{3}{\tan 30} \end{aligned}$$

$$\begin{aligned} A &= \frac{1}{2} aP \\ &= \frac{1}{2} \left(\frac{3}{\tan 30} \right) (36) \\ &\approx 93.5 \end{aligned}$$

12-3 Surface Areas of Pyramids and Cones

So, the area of the base B is about 93.5 mm^2 .

Find the surface area of the pyramid.

$$\begin{aligned}S &= \frac{1}{2}P\ell + B \\ &\approx 162 + 93.5 \\ &\approx 255.5\end{aligned}$$

Therefore, the surface area of the pyramid is about 255.5 mm^2 .

ANSWER:

$$L = 162 \text{ mm}^2 ; S \approx 255.5 \text{ mm}^2$$

13. **ARCHITECTURE** Find the lateral area of a pyramid-shaped building that has a slant height of 210 feet and a square base 332 feet by 332 feet.

SOLUTION:

The lateral area L of a regular pyramid is $L = \frac{1}{2}P\ell$, where ℓ is the slant height and P is the perimeter of the base.

Here, the base is a square of side 332 ft and the slant height is 210 ft.

$$\begin{aligned}L &= \frac{1}{2}P\ell \\ &= \frac{1}{2}(4 \times 332)(210) \\ &= 139,440\end{aligned}$$

So, the lateral area of the pyramid is $139,440 \text{ ft}^2$.

ANSWER:

$$139,440 \text{ ft}^2$$

12-3 Surface Areas of Pyramids and Cones

Find the lateral area and surface area of each cone. Round to the nearest tenth.

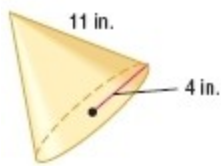

14.

SOLUTION:

The lateral area L of a right circular cone is $L = \pi r \ell$ where r is the radius of the base and ℓ is the slant height. Here, the radius is 4 in and the slant height is 11 in.

$$\begin{aligned} L &= \pi r \ell \\ &= \pi(4)(11) \\ &\approx 138.2 \end{aligned}$$

So, the lateral area of the cone is about 138.2 in^2 .

The surface area S of a right circular cone is $S = \pi r \ell + \pi r^2$, where r is the radius of the base and ℓ is the slant height.

$$\begin{aligned} S &= \pi r \ell + \pi r^2 \\ &= \pi(4)(11) + \pi(4)^2 \\ &= 44\pi + 16\pi \\ &\approx 188.5 \end{aligned}$$

Therefore, the surface area of the cone is about 188.5 in^2 .

ANSWER:

$$L \approx 138.2 \text{ in}^2 ; S \approx 188.5 \text{ in}^2$$

12-3 Surface Areas of Pyramids and Cones

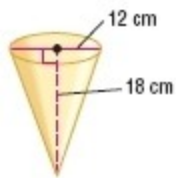

15.

SOLUTION:

The radius of the cone is $\frac{12}{2}$ or 6 cm and the height is 18 cm. Use the Pythagorean Theorem to find the slant height ℓ .

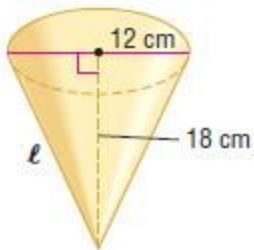

$$\ell^2 = 6^2 + 18^2$$

$$\ell^2 = 36 + 324$$

$$\ell = \sqrt{360} \text{ or } 6\sqrt{10}$$

Find the lateral and surface areas of the cone.

$$\begin{aligned} L &= \pi r \ell \\ &= \pi(6)(6\sqrt{10}) \\ &\approx 357.6 \end{aligned}$$

So, the lateral area of the cone is about 357.6 cm^2 .

$$\begin{aligned} S &= \pi r \ell + \pi r^2 \\ &= \pi(6)(6\sqrt{10}) + \pi(6)^2 \\ &\approx 470.7 \end{aligned}$$

Therefore, the surface area of the cone is about 470.7 cm^2 .

ANSWER:

$$L \approx 357.6 \text{ cm}^2 ; S \approx 470.7 \text{ cm}^2$$

12-3 Surface Areas of Pyramids and Cones

16. The diameter is 3.4 centimeters, and the slant height is 6.5 centimeters.

SOLUTION:

The radius of the cone is $r = \frac{3.4}{2}$ or 1.7 cm.

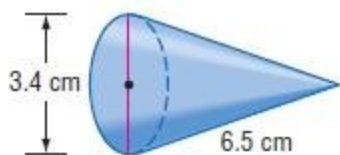

Find the lateral and surface areas.

$$\begin{aligned}L &= \pi r \ell \\ &= \pi(1.7)(6.5) \\ &\approx 34.7\end{aligned}$$

So, the lateral area of the cone is about 34.7 cm^2 .

$$\begin{aligned}S &= \pi r \ell + \pi r^2 \\ &= \pi(1.7)(6.5) + \pi(1.7)^2 \\ &\approx 43.8\end{aligned}$$

Therefore, the surface area of the cone is about 43.8 cm^2 .

ANSWER:

$$L \approx 34.7 \text{ cm}^2 ; S \approx 43.8 \text{ cm}^2$$

12-3 Surface Areas of Pyramids and Cones

17. The altitude is 5 feet, and the slant height is $9\frac{1}{2}$ feet.

SOLUTION:

The altitude of the cone is 5 feet and the slant height is $9\frac{1}{2}$ or 9.5 feet. Use the Pythagorean Theorem to find the radius.

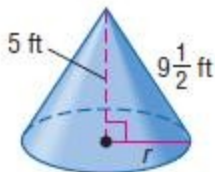

$$\begin{aligned}r^2 + 5^2 &= (9.5)^2 \\r^2 &= 90.25 - 25 \\r &= \sqrt{65.25}\end{aligned}$$

Find the lateral and surface areas of the cone.

$$\begin{aligned}L &= \pi r \ell \\&= \pi(\sqrt{65.25})(9.5) \\&\approx 241.1\end{aligned}$$

So, the lateral area of the cone is about 241.1 ft^2 .

$$\begin{aligned}S &= \pi r \ell + \pi r^2 \\&= \pi(\sqrt{65.25})(9.5) + \pi(\sqrt{65.25})^2 \\&\approx 241.1 + 205.0 \\&\approx 446.1\end{aligned}$$

Therefore, the surface area of the cone is about 446.1 ft^2 .

ANSWER:

$$L \approx 241.1 \text{ ft}^2 ; S \approx 446.1 \text{ ft}^2$$

12-3 Surface Areas of Pyramids and Cones

18. **MOUNTAINS** A conical mountain has a radius of 1.6 kilometers and a height of 0.5 kilometer. What is the lateral area of the mountain?

SOLUTION:

The radius of the conical mountain is 1.6 kilometers and the height is 0.5 kilometers. Use the Pythagorean Theorem to find the slant height.

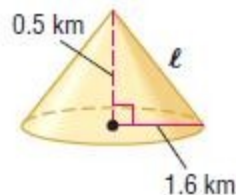

$$l^2 = (0.5)^2 + (1.6)^2$$

$$l^2 = 0.25 + 2.56$$

$$l = \sqrt{2.81}$$

Find the lateral area L of the conical mountain.

$$\begin{aligned} L &= \pi r l \\ &= \pi(1.6)(\sqrt{2.81}) \\ &\approx 8.4 \end{aligned}$$

Therefore, the lateral area is about 8.4 km^2 .

ANSWER:

$$8.4 \text{ km}^2$$

12-3 Surface Areas of Pyramids and Cones

19. **HISTORY** Archaeologists recently discovered a 1500-year-old pyramid in Mexico City. The square pyramid measures 165 yards on each side and once stood 20 yards tall. What was the original lateral area of the pyramid?

SOLUTION:

The pyramid has a square base with sides having lengths of 165 yards and a height of 20 yards. Use the Pythagorean Theorem to find the slant height.

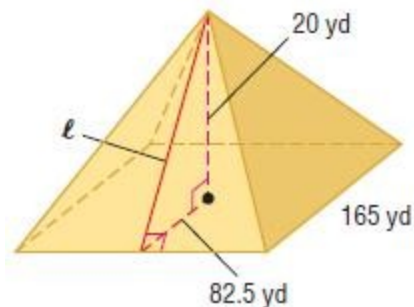

$$l^2 = 82.5^2 + 20^2$$

$$l^2 = 6806.25 + 400$$

$$l = \sqrt{7206.25}$$

Find the lateral area L of a regular pyramid.

$$L = \frac{1}{2}P\ell$$

$$= \frac{1}{2}(4 \times 165)(\sqrt{7206.25})$$

$$\approx 28,013.6$$

Therefore, the lateral area of the pyramid is about 28,013.6 yd^2 .

ANSWER:

$$28,013.6 \text{ yd}^2$$

20. Describe two polyhedrons that have 7 faces.

SOLUTION:

A hexagonal pyramid has 6 triangular lateral faces and one hexagonal base. A pentagonal prism has 5 rectangular lateral faces and two pentagonal bases.

ANSWER:

hexagonal pyramid, pentagonal prism

12-3 Surface Areas of Pyramids and Cones

21. What is the sum of the number of faces, vertices, and edges of an octagonal pyramid?

SOLUTION:

In any pyramid, the number of faces is $n + 1$ where n is the number of sides of the base, the number of edges is $2n$ and the number of vertices is $n + 1$. In an octagonal prism, the base has 8 sides. Therefore, the sum of the number of faces, vertices, and edges is $(8 + 1) + (2(8)) + (8 + 1) = 34$.

ANSWER:

34

22. **TEPEES** The dimensions of two canvas tepees are shown in the table at the right. Not including the floors, approximately how much more canvas is used to make Tepee B than Tepee A?

Tepee	Diameter (ft)	Height (ft)
A	14	6
B	20	9

SOLUTION:

The tepees are in the shape of a right cone. To find the amount of canvas used for each tepee, we need to find its lateral area. The radius of Tepee A is $\frac{14}{2}$ or 7 feet and the radius of Tepee B is $\frac{20}{2}$ or 10 feet

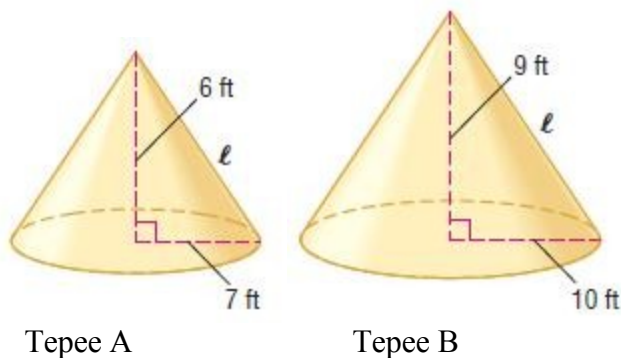

Use the Pythagorean Theorem to find the slant height l of each tepee and then find the lateral area for each cone.

$$\begin{aligned}(\ell_A)^2 &= 6^2 + 7^2 \\ \ell_A &= \sqrt{85}\end{aligned}$$

$$\begin{aligned}(\ell_B)^2 &= 9^2 + 10^2 \\ \ell_B &= \sqrt{181}\end{aligned}$$

$$\begin{aligned}L_A &= \pi r \ell \\ &= \pi(7)(\sqrt{85}) \\ &\approx 202.75\end{aligned}$$

12-3 Surface Areas of Pyramids and Cones

$$\begin{aligned}L_B &= \pi r \ell \\ &= \pi(10)(\sqrt{181}) \\ &\approx 422.66\end{aligned}$$

To find how much more canvas is used to make Tepee B than Tepee A, subtract the lateral areas.

$$\begin{aligned}L_B - L_A &\approx 422.66 - 202.75 \\ &\approx 219.91\end{aligned}$$

Tepee B will use about 219.9 ft^2 more canvas than Tepee A.

ANSWER:

about 219.9 ft^2

23. The surface area of a square pyramid is 24 square millimeters and the base area is 4 square millimeters. What is the slant height of the pyramid?

SOLUTION:

Let x be the side of the square base. The area of the base is 4, so x is 2. Solve for l .

$$\begin{aligned}S &= L + B \\ S &= \frac{1}{2}Pl + x^2 \\ 24 &= \frac{1}{2}[(4)(x)]l + x^2 \\ 24 &= \frac{1}{2}[(4)(2)]l + 2^2 \\ 24 &= 4l + 4 \\ 20 &= 4l \\ 5 &= l\end{aligned}$$

ANSWER:

5 mm

12-3 Surface Areas of Pyramids and Cones

24. The surface area of a cone is 18π square inches and the radius of the base is 3 inches. What is the slant height of the cone?

SOLUTION:

The surface area S of a right circular cone is $S = \pi r\ell + \pi r^2$, where r is the radius of the base and ℓ is the slant height.

Solve for ℓ .

$$\pi(3)\ell + \pi(3)^2 = 18\pi$$

$$9 + 3\ell = 18$$

$$\ell = \frac{18 - 9}{3}$$

$$= 3$$

Therefore, the slant height of the cone is 3 in.

ANSWER:

3 in.

12-3 Surface Areas of Pyramids and Cones

25. The surface area of a triangular pyramid is 532 square centimeters, and the base is 24 centimeters wide with a hypotenuse of 25 centimeters. What is the slant height of the pyramid?

SOLUTION:

The base of the triangular pyramid is a right triangle (since the measure of the hypotenuse is 25 centimeters). Use the Pythagorean Theorem to find a , the length of the third side of the base. Then find the perimeter and area of the base.

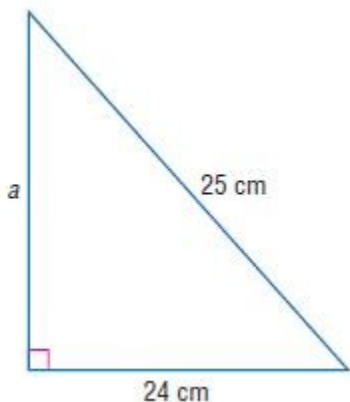

$$a^2 + 24^2 = 25^2$$
$$a^2 = 625 - 576$$

$$a = \sqrt{49} \text{ or } 7$$

$$P = 7 + 24 + 25 \text{ or } 56 \text{ cm}$$

$$A = \frac{1}{2}bh$$
$$= \frac{1}{2}(24)(7)$$
$$= 84$$

Replace S with 532, P with 56, and B with 84 in the formula for the surface area of a pyramid. Then solve for the slant height ℓ .

$$S = \frac{1}{2}P\ell + B$$
$$532 = \frac{1}{2}(56)\ell + 84$$
$$448 = 28\ell$$
$$16 = \ell$$

Therefore, the slant height of the pyramid is 16 cm.

ANSWER:

16 cm

12-3 Surface Areas of Pyramids and Cones

26. Find the lateral area of the tent to the nearest tenth.

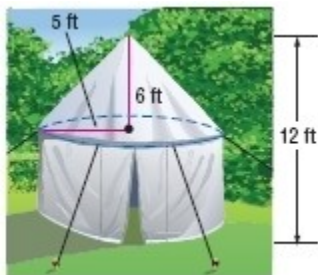

SOLUTION:

The tent is a combination of a cylinder and a cone. The cone has a radius of 5 feet and a height of 6 feet. Use the Pythagorean Theorem to find the slant height of the cone.

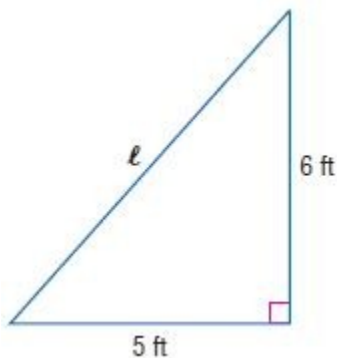

$$l^2 = 5^2 + 6^2$$

$$l^2 = 61$$

$$l = \sqrt{61}$$

The cylinder has a radius of 5 feet and a height of $12 - 6$ or 6 feet.

Find the sum of the lateral areas of the cone and cylinder to find the lateral area of the tent.

$$\begin{aligned} L_{\text{Tent}} &= L_{\text{cone}} + L_{\text{cylinder}} \\ &= \pi r l + 2\pi r h \\ &= \pi(5)(\sqrt{61}) + 2\pi(5)(6) \\ &\approx 311.2 \end{aligned}$$

Therefore, the lateral area of the tent is about 311.2 ft^2 .

ANSWER:

$$311.2 \text{ ft}^2$$

12-3 Surface Areas of Pyramids and Cones

27. Find the surface area of the tank. Write in terms of π .

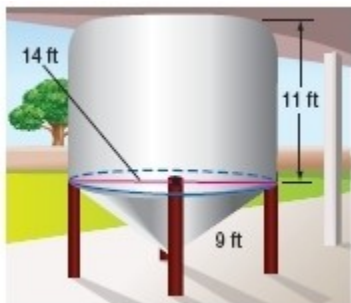

SOLUTION:

The tank is a combination of a cylinder and a cone. The cylinder has a height of 11 feet and a radius of $\frac{14}{2}$ or 7 feet. The cone has a radius of $\frac{14}{2}$ or 7 feet and a slant height of 9 feet. The surface area of the tank is the sum of the lateral area of a cylinder, the lateral area of the cone, and the area of the one base of the cylinder.

$$\begin{aligned}L_{\text{Tank}} &= L_{\text{cone}} + L_{\text{cylinder}} + B \\&= \pi r \ell + 2\pi r h + \pi r^2 \\&= \pi(7)(9) + 2\pi(7)(11) + \pi(7)^2 \\&= 63\pi + 154\pi + 49\pi \\&= 266\pi\end{aligned}$$

Therefore, the surface area of the tank is $266\pi \text{ ft}^2$.

ANSWER:

$$266\pi \text{ ft}^2$$

12-3 Surface Areas of Pyramids and Cones

28. **CHANGING DIMENSIONS** A cone has a radius of 6 centimeters and a slant height of 12 centimeters. Describe how each change affects the surface area of the cone.

- The radius and the slant height are doubled.
- The radius and the slant height are divided by 3.

SOLUTION:

a. The surface area S of a right circular cone is $S = \pi r \ell + \pi r^2$, where r is the radius of the base and ℓ is the slant height.

When the radius and the slant height are doubled the surface area S' is given by the formula

$$\begin{aligned} S' &= \pi(2r)(2\ell) + \pi(2r)^2 \\ &= 4\pi r \ell + 4\pi r^2 \\ &= 4(\pi r \ell + \pi r^2) \\ &= 4S \end{aligned}$$

Therefore, when the radius and the slant height are doubled, the surface area is multiplied by 4.

b. When the radius and the slant height are divided by 3 the surface area S' is given by the formula

$$\begin{aligned} S' &= \pi\left(\frac{1}{3}r\right)\left(\frac{1}{3}\ell\right) + \pi\left(\frac{1}{3}r\right)^2 \\ &= \frac{1}{9}\pi r \ell + \frac{1}{9}\pi r^2 \\ &= \frac{1}{9}(\pi r \ell + \pi r^2) \\ &= \frac{1}{9}S \end{aligned}$$

Therefore, when the radius and the slant height are divided by 3, the surface area is divided by 9.

ANSWER:

- The surface area is multiplied by 4.
- The surface area is divided by 9.

12-3 Surface Areas of Pyramids and Cones

29. **CCSS TOOLS** A solid has the net shown.

- Describe the solid.
- Make a sketch of the solid.



SOLUTION:

- The middle piece is the base, which is a square. The outer pieces are triangles, so they will form a point at the top, making the figure a pyramid. The triangles are not congruent. Two of them appear to be isosceles while the other two are not. This means the pyramid will be nonregular.
- Sample answer: Draw the square base and make the pyramid oblique by having the point off to the side.

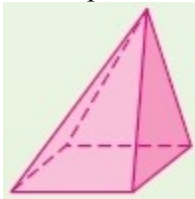

ANSWER:

- nonregular pyramid with a square base
- Sample answer:

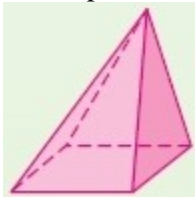

12-3 Surface Areas of Pyramids and Cones

Sketch each solid and a net that represents the solid.

30. hexagonal pyramid

SOLUTION:

Sketch the hexagon base first. Draw lines up from each vertex of the base. The lines should meet at a point, forming six congruent triangles. Use dashed lines to indicate the hidden edges.

For the net, sketch the base first. Attach one of the triangles to one of the sides of the base. Connect the other triangles to either side of the first triangle.

Sample answer:

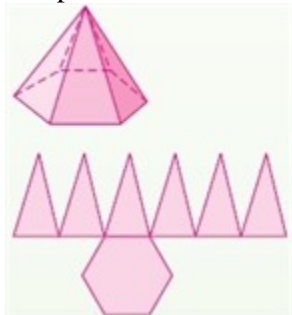

ANSWER:

Sample answer:

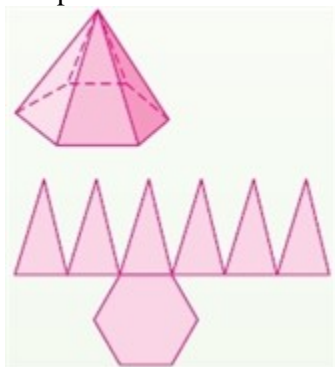

12-3 Surface Areas of Pyramids and Cones

31. rectangular pyramid

SOLUTION:

Sketch the rectangular base first. Draw lines up from each vertex of the base. The lines should meet at a point, forming four triangles. Use dashed lines to indicate the hidden edges.

For the net, sketch the base first. Attach one of the triangles to one of the sides of the base. Connect the other triangles to either side of the first triangle.

Sample answer:

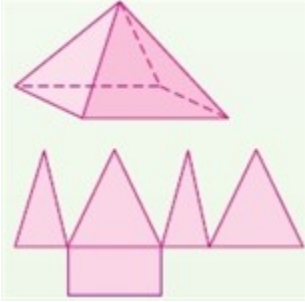

ANSWER:

Sample answer:

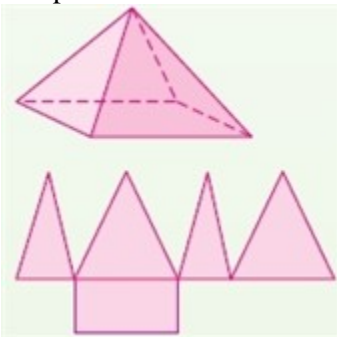

12-3 Surface Areas of Pyramids and Cones

32. **PETS** A *frustum* is the part of a solid that remains after the top portion has been cut by a plane parallel to the base. The ferret tent shown is a frustum of a regular pyramid.

a. Describe the faces of the solid.

b. Find the lateral area and surface area of the frustum formed by the tent.

c. Another pet tent is made by cutting the top half off of a pyramid with a height of 12 centimeters, slant height of 20 centimeters and square base with side lengths of 32 centimeters. Find the surface area of the frustum.

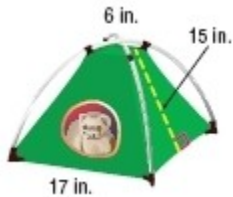

SOLUTION:

a. The two bases are squares and the 4 lateral faces are trapezoids.

b. Each lateral face is a trapezoid with the bases 6 in. and 17 in. and height 15 in. The area A of a trapezoid with bases b_1 , b_2 and the height h is given by the formula $A = \frac{1}{2}h(b_1 + b_2)$.

The lateral area of the solid is $4\left(\frac{1}{2}(15)(6+17)\right) = 690 \text{ in}^2$.

The bases are squares of sides 6 in. and 17 in. respectively. Therefore, the surface area is

$$(6)^2 + (17)^2 + 690 = 1015 \text{ in}^2.$$

c. When the top half of a pyramid with a height of 12 cm, slant height of 20 cm and square base with side lengths of 32 cm is cut, the height of the frustum will be 6 cm, the slant height 10 cm and the length of each side of the upper base will be 16 cm.

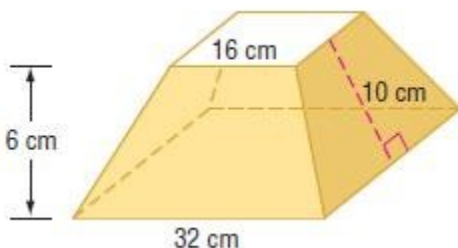

The total surface area of the frustum will be $(32)^2 + (16)^2 + 4\left(\frac{1}{2}(10)(16+32)\right) = 2240 \text{ cm}^2$.

ANSWER:

a. 4 trapezoids, 2 squares

b. 690 in^2 ; 1015 in^2

c. 2240 cm^2

12-3 Surface Areas of Pyramids and Cones

Find the surface area of each composite solid. Round to the nearest tenth.

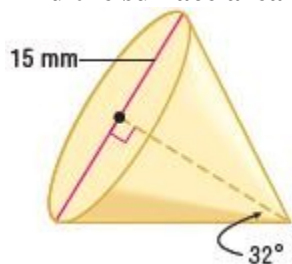

33.

SOLUTION:

We need to determine the slant height l . Use trigonometry.

$$\sin x = \frac{\text{opposite}}{\text{hypotenuse}}$$

$$\sin 32 = \frac{7.5}{l}$$

$$l \sin 32 = 7.5$$

$$l = \frac{7.5}{\sin 32}$$

$$l \approx 14.2$$

Use the exact value of l to find the lateral area.

$$\begin{aligned} L &= \pi r l \\ &= \pi(7.5) \left(\frac{7.5}{\sin 32} \right) \\ &\approx 333.5 \end{aligned}$$

Find the surface area.

$$\begin{aligned} S &= L + B \\ &= \pi r l + \pi r^2 \\ &= \pi(7.5) \left(\frac{7.5}{\sin 32} \right) + \pi(7.5)^2 \\ &\approx 510.2 \end{aligned}$$

ANSWER:

333.5; 510.2

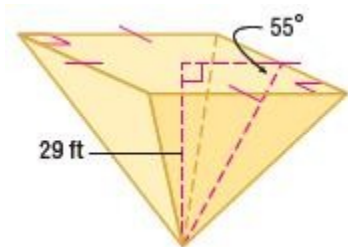

34.

SOLUTION:

We need to determine the slant height l and the length of the base b . Use trigonometry.

12-3 Surface Areas of Pyramids and Cones

Slant height:

$$\sin x = \frac{\text{opposite}}{\text{hypotenuse}}$$

$$\sin 55 = \frac{29}{l}$$

$$l \sin 55 = 29$$

$$l = \frac{29}{\sin 55}$$

$$l \approx 35.4$$

Base:

$$\tan x = \frac{\text{opposite}}{\text{adjacent}}$$

$$\tan 55 = \frac{29}{x}$$

$$x \tan 55 = 29$$

$$x = \frac{29}{\tan 55}$$

$$x \approx 20.3$$

This value of x is the apothem, which is only half of the length of the sides of the base.

Use the exact values of l and x to find the lateral area.

$$\begin{aligned} L &= \frac{1}{2}Pl \\ &= \frac{1}{2} \left[(4) \left(\frac{2(29)}{\tan 55} \right) \left(\frac{29}{\sin 55} \right) \right] \\ &\approx 2875.5 \end{aligned}$$

Now find the surface area.

$$\begin{aligned} S &= L + B \\ &= \frac{1}{2}Pl + x^2 \\ &= \frac{1}{2} \left[(4) \left(\frac{2(29)}{\tan 55} \right) \left(\frac{29}{\sin 55} \right) \right] + \left(\frac{2(29)}{\tan 55} \right)^2 \\ &\approx 4524.9 \end{aligned}$$

ANSWER:

2875.5; 4524.9

35. **MULTIPLE REPRESENTATIONS** In this problem, you will investigate the lateral and surface area of a square pyramid with a base edge of 3 units.

a. GEOMETRIC Sketch the pyramid on isometric dot paper.

12-3 Surface Areas of Pyramids and Cones

b. TABULAR Make a table showing the lateral areas of the pyramid for a slant heights of 3 units and 9 units.

c. VERBAL Describe what happens to the lateral area of the pyramid if the slant height is tripled.

d. ANALYTICAL Make a conjecture about how the lateral area of a square pyramid is affected if both the slant height and the base edge are tripled. Then test your conjecture.

SOLUTION:

a. Sample answer:

Start with the initial vertex. Go 3 units left and 3 units right, and make 2 more vertices. Go 3 units right and 3 units left from these new vertices to connect at the last vertex of the base. The height is not provided, so select a random point directly above the first vertex and connect the other vertices to it.



b. The formula of lateral area is $0.5Pl$. The perimeter is 12, so multiple the slant height by $(0.5)(12)$.

Slant Height (units)	Lateral Area (units ²)
1	6
3	18
9	54

c. The lateral area is tripled as well. $6 \times 3 = 18$; $18 \times 3 = 54$

d.

$$s = 4, l = 3$$

$$\begin{aligned}L &= \frac{1}{2}Pl \\ &= \frac{1}{2}[(4)(4)](3) \\ &= 24\end{aligned}$$

$$s = 12, l = 9$$

$$\begin{aligned}L &= \frac{1}{2}Pl \\ &= \frac{1}{2}[(4)(12)](9) \\ &= 216\end{aligned}$$

The lateral area is multiplied by 3^2 or 9. We can also show this using variables.

12-3 Surface Areas of Pyramids and Cones

$$\begin{aligned}L &= \frac{1}{2}Pl \\ &= \frac{1}{2}[(4)(s)]l \\ &= 2sl\end{aligned}$$

$$s = 12, l = 9$$

$$\begin{aligned}L &= \frac{1}{2}Pl \\ &= \frac{1}{2}[(4)(3s)](3l) \\ &= 18sl\end{aligned}$$

$$18sl = 9 \times 2sl.$$

ANSWER:

a. Sample answer:



b.

Slant Height (units)	Lateral Area (units ²)
1	6
3	18
9	54

c. The lateral area is tripled.

d. The lateral area is multiplied by 3^2 or 9.

12-3 Surface Areas of Pyramids and Cones

36. **WRITING IN MATH** Explain why an oblique solid does not have a slant height.

SOLUTION:

The distance from the vertex to the base is not the same for each point on the circumference of the base. Notice that points A and B are both on the circumference of the base, but are not equidistant from the vertex. For regular cones, this distance (the slant height) is always constant.

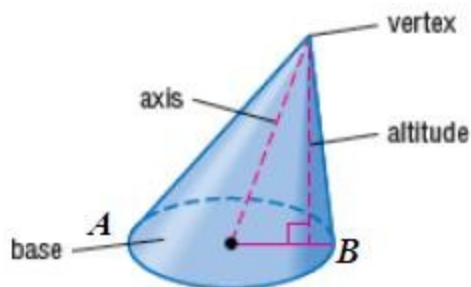

ANSWER:

The distance from the vertex to the base is not the same for each point on the circumference of the base.

12-3 Surface Areas of Pyramids and Cones

37. **REASONING** Classify the following statement as *sometimes*, *always*, or *never* true. Justify your reasoning.

The surface area of a cone of radius r and height h is less than the surface area of a cylinder of radius r and height h .

SOLUTION:

Consider the cylinder below.

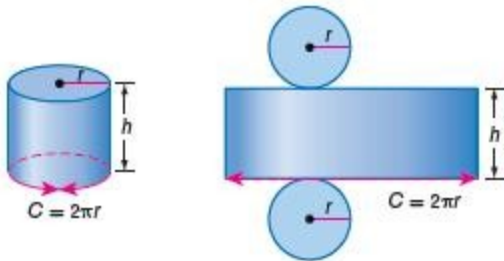

The surface area of this cylinder is $2\pi rh + 2\pi r^2$.

Now, consider a cone with the same base and height.

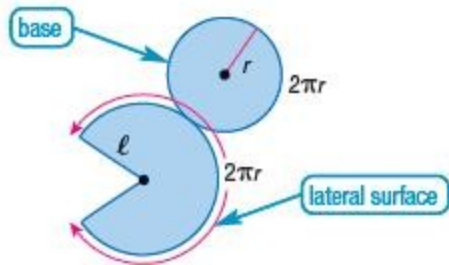

The surface area for the cone is $\pi rl + \pi r^2$. Compare the two formulas.

$$\text{Cylinder} \stackrel{?}{=} \text{Cone}$$

$$2\pi rh + 2\pi r^2 \stackrel{?}{=} \pi rl + \pi r^2$$

$$2\pi rh + \pi r^2 \stackrel{?}{=} \pi rl$$

$$\pi r(2h + r) \stackrel{?}{=} \pi rl$$

$$2h + r \stackrel{?}{=} l$$

The values h , r , and l form a triangle, so $r + h$ must be greater than l . Therefore, $2h + r$ is also greater than l .

The statement is *always* true.

ANSWER:

Always; if the heights and radii are the same, the surface area of the cylinder will be greater since it has two circular bases and additional lateral area.

38. **REASONING** A cone and a square pyramid have the same surface area. If the areas of their bases are also equal, do they have the same slant height as well? Explain.

12-3 Surface Areas of Pyramids and Cones

SOLUTION:

The surface area of the cone is given by $S_{\text{cone}} = \pi r \ell_c + \pi r^2$ where r is the radius of the base and ℓ_c is the slant height. The surface area of the square pyramid is given by $S_{\text{pyramid}} = s^2 + \frac{1}{2}P\ell_p$ where s is the length of each side of the square base and ℓ_p is the slant height of the pyramid. Since the base of the pyramid is a square, the perimeter is $P = 4s$. The area of the base of the cone and the pyramid are the same, so $\pi r^2 = s^2$.

The cone and the square pyramid have the same surface areas, so set the two expressions equal. Subtract the area of the base from each side and then solve for ℓ_c .

$$\begin{aligned}S_{\text{cone}} &= S_{\text{pyramid}} \\ \pi r \ell_c + \pi r^2 &= s^2 + \frac{1}{2}(4s)\ell_p \\ \pi r \ell_c &= 2s\ell_p \\ \ell_c &= \frac{2s\ell_p}{\pi r}\end{aligned}$$

Use the equal base areas to find an equivalent expression for s .

$$\begin{aligned}\pi r^2 &= s^2 \\ \sqrt{\pi r^2} &= s \\ r\sqrt{\pi} &= s\end{aligned}$$

Substitute for s in the expression for ℓ_c .

$$\begin{aligned}\ell_c &= \frac{2s\ell_p}{\pi r} \\ \ell_c &= \frac{2(r\sqrt{\pi})\ell_p}{\pi r} \\ \ell_c &= \left(\frac{2\sqrt{\pi}}{\pi}\right)\ell_p \\ \ell_c &\approx 1.13\ell_p\end{aligned}$$

The slant height of the cone is $\frac{2\sqrt{\pi}}{\pi}$ or about 1.13 times greater than the slant height of the pyramid. Therefore, they are not equal.

ANSWER:

They are not equal. The slant height of the cone is $\frac{2\sqrt{\pi}}{\pi}$ or about 1.13 times greater than the slant height of the square pyramid.

12-3 Surface Areas of Pyramids and Cones

39. **OPEN ENDED** Describe a pyramid that has a total surface area of 100 square units.

SOLUTION:

We will use the formula for a square pyramid. In this formula, we know S is 100, but we do not know s or l . Manipulate the equation to get l by itself.

$$S = L + B$$

$$100 = \frac{1}{2}Pl + s^2$$

$$100 = \frac{1}{2}[4s]l + s^2$$

$$100 = 2sl + s^2$$

$$100 - s^2 = 2sl$$

$$\frac{100 - s^2}{2s} = l$$

We now have l in terms of s . We can provide a value for s and then get a corresponding value for l . Set s equal to 5.

$$\frac{100 - s^2}{2s} = l$$

$$\frac{100 - 5^2}{2(5)} = l$$

$$\frac{100 - 25}{10} = l$$

$$7.5 = l$$

We have a square pyramid with a base edge of 5 units and a slant height of 7.5 units. Plug these values into the original equation to confirm the surface area S is 100.

$$S = L + B$$

$$= \frac{1}{2}Pl + s^2$$

$$= \frac{1}{2}[(4)(5)](7.5) + 5^2$$

$$= 75 + 25$$

$$= 100$$

ANSWER:

Sample answer: a square pyramid with a base edge of 5 units and a slant height of 7.5 units

40. **CCSS ARGUMENTS** Determine whether the following statement is *true* or *false*. Explain your reasoning.

A square pyramid and a cone both have height h units and base perimeter P units. Therefore, they have the same total surface area.

SOLUTION:

The surface area of a square pyramid is $S = \frac{1}{2}Pl + B$. The surface area of a cone is $S = \pi r l + \pi r^2$.

12-3 Surface Areas of Pyramids and Cones

We know that the perimeter of the square base is equal to the perimeter (circumference) of the circular base. We can use this information to get the side s in terms of the radius r .

$$P = C$$

$$4s = 2\pi r$$

$$s = \frac{2\pi r}{4}$$

$$s = \frac{\pi r}{2}$$

Now we can compare the areas of the bases.

$$\text{Area (circle)} \stackrel{?}{=} \text{Area (square)}$$

$$\pi r^2 \stackrel{?}{=} s^2$$

$$\pi r^2 \stackrel{?}{=} \left(\frac{\pi r}{2}\right)^2$$

$$\pi r^2 \stackrel{?}{=} \frac{\pi^2 r^2}{4}$$

$$\frac{\pi r^2}{\pi r^2} \stackrel{?}{=} \frac{\pi^2 r^2}{4\pi r^2}$$

$$1 \stackrel{?}{=} \frac{\pi}{4}$$

$$1 > \frac{3.14}{4}$$

The area of the circular base is greater than the area of the square base.

Now, we need to compare the lateral areas. Find l .

For the circle, the radius, the slant height, and the height form a right triangle. For the square, half of the side, the slant height, and the height form a right triangle.

We have determined that the side of the square is $\frac{\pi r}{2}$, so half of the side is $\frac{\pi r}{4}$. This value is less than r , so we know that the radius of the square is less than the radius of the circle, so the slant height of the cone is greater than the slant height of the pyramid.

Now, compare the lateral areas.

12-3 Surface Areas of Pyramids and Cones

$$L(\text{cone}) \stackrel{?}{=} L(\text{pyramid})$$

$$\pi r l_c \stackrel{?}{=} \frac{1}{2} P l_p$$

$$\pi r l_c \stackrel{?}{=} \frac{1}{2} (4s) l_p$$

$$\pi r l_c \stackrel{?}{=} 2s l_p$$

$$\pi r l_c \stackrel{?}{=} 2 \left(\frac{\pi r}{2} \right) l_p$$

$$\pi r l_c \stackrel{?}{=} \pi r l_p$$

$$l_c > l_p$$

The slant height of the cone is greater than the slant height of the pyramid, so the lateral area of the cone is greater than the lateral area of the pyramid.

The lateral area and the base of the cone are greater than the lateral area and base of the pyramid, so the statement is *false*.

ANSWER:

False; the lateral area and the base of the cone are greater than the lateral area and base of the pyramid.

12-3 Surface Areas of Pyramids and Cones

41. **WRITING IN MATH** Describe how to find the surface area of a regular polygonal pyramid with an n -gon base, height h units, and an apothem of a units.

SOLUTION:

Use the apothem, the height, and the Pythagorean Theorem to find the slant height ℓ of the pyramid.

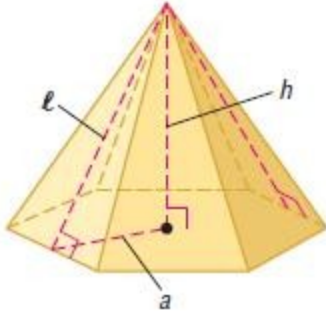

Divide the regular n -gon for the base into congruent isosceles triangles. Each central angle of the n -gon will have a measure of $\frac{360}{n}$, so the measure of the angle in the right triangle created by the apothem will be $\frac{360}{n} \div 2$ or $\frac{360}{2n}$. The apothem will bisect the base of the isosceles triangle so if each side of the regular polygon is s , then the side of the right triangle is $\frac{s}{2}$. Use a trigonometric ratio to find the length of a side s .

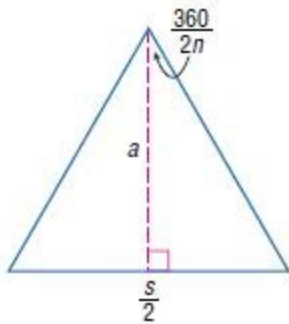

Then find the perimeter by using $P = n \times s$.

Finally, use $S = \frac{1}{2}P\ell + B$ to find the surface area where B is the area of the regular n -gon and is given by

$$B = \frac{1}{2}Pa.$$

ANSWER:

Use the apothem, the height, and the Pythagorean Theorem to find the slant height ℓ of the pyramid. Then use the central angle of the n -gon and the apothem to find the length of one side of the n -gon. Then find the perimeter.

Finally, use $S = \frac{1}{2}P\ell + B$ to find the surface area. The area of the base B is $\frac{1}{2}Pa$.

12-3 Surface Areas of Pyramids and Cones

42. The top of a gazebo in a park is in the shape of a regular pentagonal pyramid. Each side of the pentagon is 10 feet long. If the slant height of the roof is about 6.9 feet, what is the lateral roof area?

A 34.5 ft^2

B 50 ft^2

C 172.5 ft^2

D 250 ft^2

SOLUTION:

The lateral area L of a regular pyramid is $L = \frac{1}{2}P\ell$, where ℓ is the slant height and P is the perimeter of the base.

Here, the base is a regular pentagon of side 10 ft. and the slant height is 6.9 ft.

$$\begin{aligned} L &= \frac{1}{2}P\ell \\ &= \frac{1}{2}(5 \times 10)(6.9) \\ &= 172.5 \end{aligned}$$

The lateral area of the pyramid is 172.5 ft^2 .

Therefore, the correct choice is C.

ANSWER:

C

12-3 Surface Areas of Pyramids and Cones

43. **SHORT RESPONSE** What is the surface area of a cone with the dimensions shown?

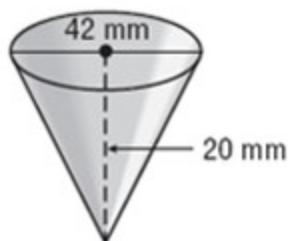

SOLUTION:

The radius of the cone is $\frac{42}{2}$ or 21 mm and the height is 20 mm. Use Pythagorean Theorem to find the slant height ℓ .

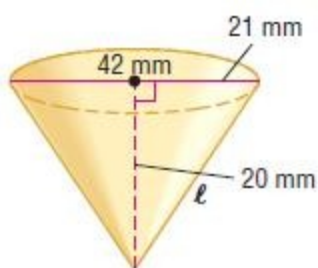

$$\ell^2 = 21^2 + 20^2$$

$$\ell^2 = 441 + 400$$

$$\ell = \sqrt{841} \text{ or } 29$$

Find the surface area.

$$\begin{aligned} S &= \pi r \ell + \pi r^2 \\ &= \pi(21)(29) + \pi(21)^2 \\ &= 1050\pi \\ &\approx 3299 \end{aligned}$$

Therefore, the surface area of the cone is about 3299 mm^2 .

ANSWER:

$$3299 \text{ mm}^2$$

12-3 Surface Areas of Pyramids and Cones

44. **ALGEBRA** Yu-Jun's craft store sells 3 handmade barrettes for \$9.99. Which expression can be used to find the total cost c of x barrettes?

F $C = \frac{9.99}{x}$

G $C = 9.99x$

H $C = 3.33x$

J $C = \frac{x}{3.33}$

SOLUTION:

Three barrettes costs \$9.99. So, the cost of each barrette is $\frac{9.99}{3} = 3.33$. Then the cost C of x barrettes is given by the equation $C = 3.33x$. Therefore, the correct choice is H.

ANSWER:

H

45. **SAT/ACT** What is the slope of a line perpendicular to the line with equation $2x + 3y = 9$?

A $-\frac{3}{2}$

B $-\frac{2}{3}$

C $\frac{2}{3}$

D $\frac{3}{2}$

E $\frac{9}{2}$

SOLUTION:

Write the equation in the slope intercept form.

$$3y = -2x + 9$$

$$y = -\frac{2}{3}x + 3$$

The slope of the line is $-\frac{2}{3}$. The product of slopes of perpendicular lines is -1 . So, a line that is perpendicular to the given line will have a slope $\frac{3}{2}$. Therefore, the correct choice is D.

ANSWER:

D

12-3 Surface Areas of Pyramids and Cones

46. Find the surface area of a cylinder with a diameter of 18 cm and a height of 12 cm.

SOLUTION:

$$\begin{aligned}
 S &= 2\pi r h + 2B \\
 &= 2\pi(9)(12) + 2\pi(9)^2 \\
 &= 216\pi + 162\pi \\
 &= 378\pi \\
 &\approx 1187.5
 \end{aligned}$$

ANSWER:

$$1187.5 \text{ cm}^2$$

Use isometric dot paper and each orthographic drawing to sketch a solid.

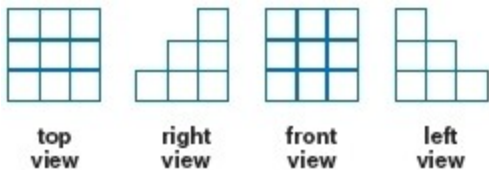

47.

SOLUTION:

top view: There are three rows and three columns. The dark segments indicate changes in depth.

left view: The figure is 3 units high in the back, 2 units high in the middle, and 1 unit high in the front.

front view: The dark segments indicate a different depth.

right view: The figure is 3 units high in the back, 2 units high in the middle, and 1 unit high in the front.

Connect the dots on the isometric dot paper to represent the edges of the solid. Shade the tops of each column.



ANSWER:



12-3 Surface Areas of Pyramids and Cones

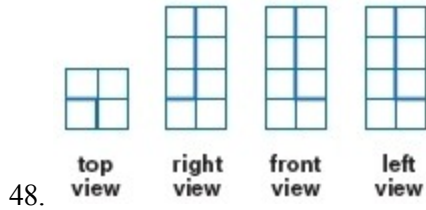

SOLUTION:

top view: There are 2 rows and 2 columns. The dark segments indicate changes in depth.

left view: The figure is 4 units high. The dark segments indicate changes in dept in the front.

front view: The dark segments indicate changes in depth on the right-hand column.

right view: The figure is 4 units high. The dark segments indicate changes in dept in the front.

Connect the dots on the isometric dot paper to represent the edges of the solid. Shade the tops of each column.



ANSWER:



12-3 Surface Areas of Pyramids and Cones

Graph each figure and its image in the given line.

$J(2, 4)$, $K(4, 0)$, $L(7, 3)$

49. $\triangle JKL$; $x = 2$

SOLUTION:

J is $(2, 4)$, K is at $(4, 0)$ and L is at $(7, 3)$. Find a corresponding point for each vertex so that a vertex and its image are equidistant from the line $x = 2$.

Draw $x = 2$.

Vertex J is 0 units left from $x = 2$, locate the point 0 units right from $x = 2$. J' would be $(2, 4)$.

Vertex K is 2 units on the from the $x = 2$, so K' would be $(-2, 0)$.

Vertex L is 5 units left from $x = 2$, locate the point 5 units right from $x = 2$. L' would be $(-3, 3)$.

Then connect the vertices, J' , K' , and L' to form the reflected image.

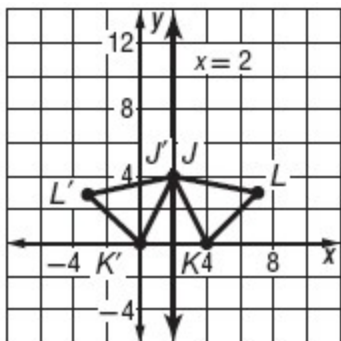

ANSWER:

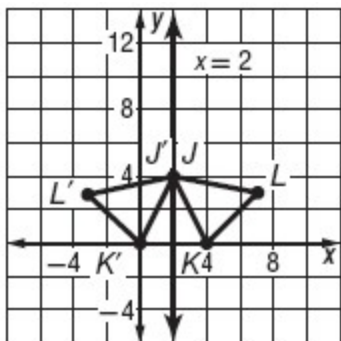

12-3 Surface Areas of Pyramids and Cones

50. $\triangle JKL$; $y = 1$

SOLUTION:

J is $(2, 4)$, K is at $(4, 0)$ and L is at $(7, 3)$. Find a corresponding point for each vertex so that a vertex and its image are equidistant from the line $y = 1$.

Draw $y = 1$.

Vertex J is 3 units above $y = 1$, locate the point 3 units below $y = 1$. J' would be $(2, -2)$.

Vertex K is 1 unit below the $y = 1$, so K' would be one unit above, at $(4, 2)$.

Vertex L is 2 units above $y = 1$, locate the point 2 units below $y = 1$. L' would be $(7, -1)$.

Then connect the vertices, J' , K' , and L' to form the reflected image.

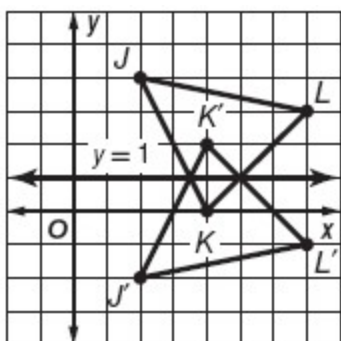

ANSWER:

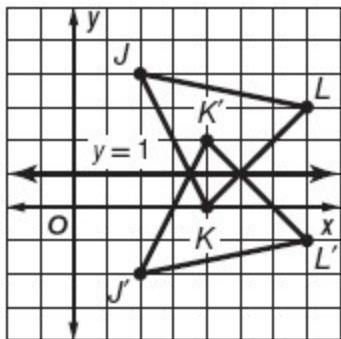

12-3 Surface Areas of Pyramids and Cones

$Q(4, 8)$, $R(1, 6)$, $S(2, 1)$, $T(5, 5)$

51. $QRST$; $y = -1$

SOLUTION:

$Q(4, 8)$ $R(1, 6)$ $S(2, 1)$ $T(5, 5)$ Find a corresponding point for each vertex so that a vertex and its image are equidistant from the line $y = -1$.

Draw $y = -1$.

Vertex Q is 9 units above $y = -1$, locate the point 9 units below $y = -1$. Q' would be $(4, -10)$.

Vertex R is 7 units above $y = -1$, locate the point 7 units below $y = -1$. R' would be $(1, -8)$.

Vertex S is 2 units above $y = -1$, locate the point 2 units below $y = -1$. S' would be $(2, -3)$.

Vertex T is 6 units above $y = -1$, locate the point 6 units below $y = -1$. T' would be $(5, -7)$.

Then connect the vertices to form the reflected image.

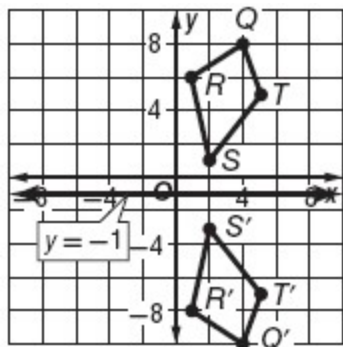

ANSWER:

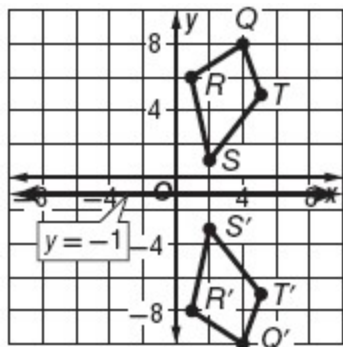

12-3 Surface Areas of Pyramids and Cones

52. $QRST$; $x = 4$

SOLUTION:

$Q(4, 8)$ $R(1, 6)$ $S(2, 1)$ $T(5, 5)$ Find a corresponding point for each vertex so that a vertex and its image are equidistant from the line $x = 4$.

Draw $x = 4$.

Vertex Q is on $x = 4$. Q' would be $(4, 8)$.

Vertex R is 3 units left of $x = 4$, locate the point 3 units right of $x = 4$. R' would be $(7, 6)$.

Vertex S is 2 units left of $x = 4$, locate the point 2 units right of $x = 4$. S' would be $(6, 1)$.

Vertex T is 1 unit right of $x = 4$, locate the point 1 unit left of $x = 4$. T' would be $(3, 5)$.

Then connect the vertices to form the reflected image.

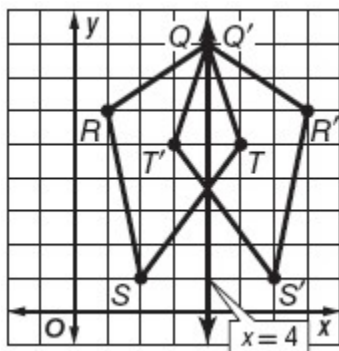

ANSWER:

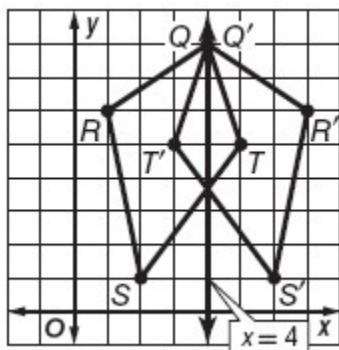

12-3 Surface Areas of Pyramids and Cones

$A(-2, 6)$, $B(-2, 1)$, $C(3, 1)$, $D(3, 4)$

53. $ABCD$; $x = 1$

SOLUTION:

$A(-2, 6)$, $B(-2, 1)$, $C(3, 1)$, $D(3, 4)$ Find a corresponding point for each vertex so that a vertex and its image are equidistant from the line $x = 1$.

Draw $x = 1$.

Vertex A is 3 units left of $x = 1$, locate the point 3 units right of $x = 1$. A' would be $(4, 6)$.

Vertex B is 3 units left of $x = 1$, locate the point 3 units right of $x = 1$. B' would be $(4, 1)$.

Vertex C is 2 units right of $x = 1$, locate the point 2 units left of $x = 1$. C' would be $(-1, 1)$.

Vertex D is 2 units right of $x = 1$, locate the point 2 units left of $x = 1$. D' would be $(-1, 4)$.

Then connect the vertices to form the reflected image.

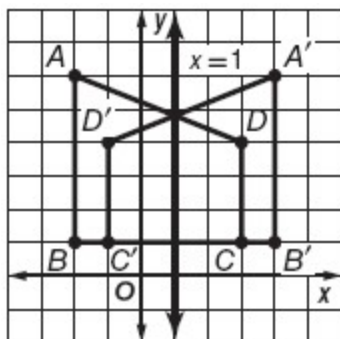

ANSWER:

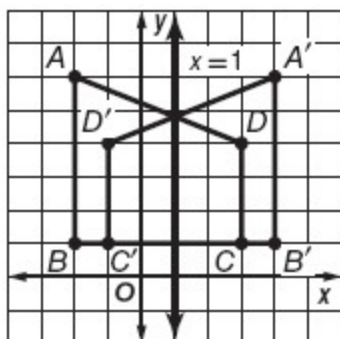

12-3 Surface Areas of Pyramids and Cones

54. $ABCD$; $y = -2$

SOLUTION:

$A(-2, 6)$, $B(-2, 1)$, $C(3, 1)$, $D(3, 4)$ Find a corresponding point for each vertex so that a vertex and its image are equidistant from the line $y = -2$.

Draw $y = -2$.

Vertex A is 8 units above $y = -2$, locate the point 8 units below $y = -2$. A' would be $(-2, -10)$.

Vertex B is 3 units above $y = -2$, locate the point 3 units below $y = -2$. B' would be $(-2, -5)$.

Vertex C is 3 units above $y = -2$, locate the point 3 units below $y = -2$. C' would be $(3, -5)$.

Vertex D is 6 units above $y = -2$, locate the point 6 units below $y = -2$. D' would be $(3, -8)$.

Then connect the vertices to form the reflected image.

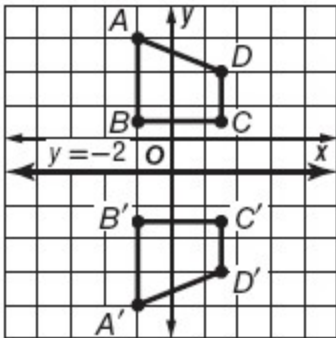

ANSWER:

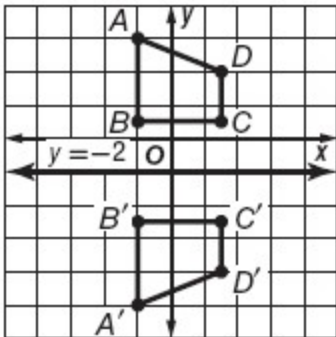

12-3 Surface Areas of Pyramids and Cones

Find the perimeter and area of each parallelogram, triangle, or composite figure. Round to the nearest tenth.

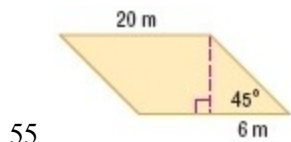

SOLUTION:

From the instruction line, the figure is a parallelogram.

The triangle on the right is 45-45-90, so the height of the parallelogram is 6, and the hypotenuse is $6\sqrt{2}$.

The perimeter of the parallelogram is $20 + 20 + 6\sqrt{2} + 6\sqrt{2} \approx 57.0$.

The area of the parallelogram is $20 \times 6 = 120$.

ANSWER:

57 m, 120 m^2

12-3 Surface Areas of Pyramids and Cones

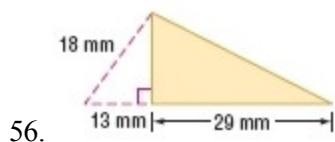

SOLUTION:

Use the Pythagorean Theorem to find the height h , of the triangle.

$$\begin{aligned}a^2 + b^2 &= c^2 \\13^2 + b^2 &= 18^2 \\b^2 &= 18^2 - 13^2 \\b^2 &= 324 - 169 \\b &= \sqrt{155} \\b &\approx 12.4\end{aligned}$$

Area of triangle:

$$\frac{1}{2}(29)(\sqrt{155}) \approx 180.5 \text{ mm}^2$$

Use the Pythagorean Theorem to find the length of the third side of the triangle.

$$\begin{aligned}a^2 + b^2 &= c^2 \\29^2 + (\sqrt{155})^2 &= c^2 \\29^2 + 155 &= c^2 \\841 + 155 &= c^2 \\\sqrt{996} &= c \\31.6 &\approx c\end{aligned}$$

The perimeter is about $12.4 + 31.6 + 29 = 73$ mm.

ANSWER:

$$73 \text{ mm}, 180.5 \text{ mm}^2$$

12-3 Surface Areas of Pyramids and Cones

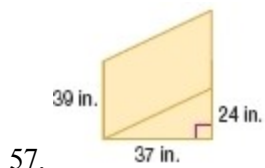

SOLUTION:

From the instruction line, the figure is a composition of a parallelogram and a triangle. It is also a trapezoid.

The right side of the trapezoid is $39 + 24 = 63$. The top of the trapezoid can be found using the Pythagorean theorem.

$$a^2 + b^2 = c^2$$

$$37^2 + 24^2 = c^2$$

$$1945 = c^2$$

$$\sqrt{1945} = c$$

$$44.1 \approx c$$

The perimeter of the trapezoid is about $39 + 63 + 37 + 44.1 \approx 183.1$.

The area of the trapezoid is $\frac{1}{2}(39 + 63)37 = 1887$.

ANSWER:

183.1 in., 1887 in²